

Status: 01/2022

Labelstek
LABELING SOLUTIONS

Products need labeling
Label printers
for industrial applications



SQUIX
Made in Germany

Contents

Label printers

Page 3	Key features
.....	Sample applications
Pages 4, 5	Left-aligned material guidance
Pages 6, 7	Centered material guidance
Page 8	Operation panels
Page 9	Print heads
.....	Print rollers
.....	Interfaces
Pages 10, 11	Technical data
Page 12	Label software
.....	Printer control
.....	Printer administration

Accessories

Pages 13, 14	Overview
Pages 15 -17	Cutting, verification, tube labeling
.....	Cutting, perforation, stacking
.....	Rewinding, unwinding
Pages 18 -20	Applicators
Page 21	All-around labeler
.....	Assembly aids

Optional label printers

Page 22	Special covers, protective chassis
Page 23	Maintenance
.....	Service
Pages 24 -26	Delivery program

Scopes of delivery, design and technical specifications correspond to the date of the printing. Subject to change. The data provided in the catalog do not represent any warranty or guarantee.



For current data see also the Internet:
www.cab.de/en/squix

Key features



SQUIX

Label printers for industrial applications

They are for use in a wide range of applications.

They have been developed with a constant focus on easy and intuitive operation as well as high reliability.

The print mechanics and the chassis are made from high-quality materials and perfectly match in shape and function.

A large number of peripherals and software enable customer-specific solutions.

Whether operated stand-alone, linked to a PC or in a network – the rugged printers are always up to the mark.

A powerful processor results in print jobs performed quickly and labels provided straight away.

- reliable and fast printing
- accurate print images
- easy to operate
- compact design
- maximum quality standards

Sample applications

PCB labeling



Type plate labeling



Cardboard and pallet labeling



Label printers with left-aligned material guidance

designed for printing in different print widths on various materials

1.1, 1.2



Slim ones

to print small labels

Label printer		SQUIX 2	
Printable resolution	dpi	300	600
Print speed	up to mm/s	250	150
Print width	up to mm	56.9	54.1

1.3, 1.4



Universal ones

Best-selling industrial devices, providing a wide range of accessories

Label printer		SQUIX 4.3		SQUIX 4	
Printable resolution	dpi	203	300	300	600
Print speed	up to mm/s	300	300	300	150
Print width	up to mm	104	108.4	105.7	105.7

Basic devices may be provided with an integral cutter.

1.5, 1.6



Wide ones

to print Odette, UCC and GS1 labels in logistics applications

Label printer		SQUIX 6.3	
Printable resolution	dpi	203	300
Print speed	up to mm/s	250	250
Print width	up to mm	168	162.6



Basic device

providing a tear-off plate

They print on labels or on continuous materials wound on rolls or fanfold. Materials are torn off on a jagged plate. Cutting is an option, so is external rewinding.



Peel-off device

providing a rewriter internally

Peeling off labels is a feature added to a basic version. Labels are separated from the liner after printing to be removed by hand or by an applicator.



The extra wide one

to print pallet or barrel labels

Label printer		A8+
Printable resolution	dpi	300
Print speed	up to mm/s	150
Print width	up to mm	216

For further information on the A8+ see www.cab.de/en/a8plus

Label printer with left-aligned material guidance

as a peel-off device providing a rewinder internally



*Label printer SQUIX 4 P,
peel-off device providing a rewinder internally*

1 Hinged cover

Material stock can be checked and entire printing processes followed through a large panoramic window.

2 Plungers

One is fixed on the inside. To get a good print image, the second one is moved to the outside margin of a label.

3 Rugged metal chassis

made of cast aluminum to assemble all the units

4 Coated print rollers

Synthetic rubber is a standard to get highly accurate print images. Silicone coating is an option for extra long service life.

5 Peel-off function

to separate labels from the liner. A powered guide roller and a pinch roller enable highly accurate imprint and peel-off.

6 Peripheral port

to plug additional modules easily and quickly. They are screw-fixed.

7 Ribbon holder

Ribbons are quick and easy to replace using three-part tightening axles.

8 Roll holder

Constant tension by means of the margin stop (spring-mounted, screw-capped) while material is fed

9 Internal rewinder

to wind labels or liners with or without a cardboard core on peel-off devices. Materials are easy to handle using a three-part tightening axle.

10 Rocker

Suspension and Teflon-made guide rollers reduce traction and improve the accuracy of print images.

11 Material guide

assembled to the rocker. By a user turning the rotary knob, the stop moves to the margin of a label.

Print image accuracy

The smaller a label, the higher are the demands. Using slip correction, print offset can be reduced by ± 0.2 mm.

Label printers with centered material guidance

1.7, 1.8



basic device



peel-off device

Precise and flexible ones

to print on all materials wound on rolls or reels or fanfold, in particular very small labels or slim continuous materials such as pressed shrink tubes.

Label printer		SQUIX 4.3M		SQUIX 4M	
Printable resolution	dpi	203	300	300	600
Print speed	up to mm/s	300	300	300	150
Print width	up to mm	104	108.4	105.7	105.7

Differences to left-aligned material guidance

1 Ribbon holder

A preprinted ruler simplifies setting a ribbon.

2 Plungers

Both positions remain fixed with all widths of material. There is no need of adjustment on the print head.

3 Roll holder

By applying the margin stop, a roll centers automatically

4 Material guide

attached next to the print roller to ensure accurate print images. Material widths are set with the help of a spindle

5 Slim print rollers

to obtain accurate print images if small materials and ribbons are in use. They prevent from roller wear, print head contamination and errors while materials are fed. Synthetic rubber coating



Label printer SQUIX 4 MP, peel-off device providing a rewinder internally

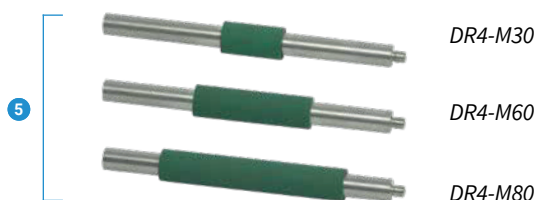

Label printers "MT" with centered material guidance and a separator

1.9



basic device

To print textile applications

In applications requiring high heat energies, a ribbon may stick with the textile tape after printing. A draw roller reliably separates the ribbon from the material.

Besides textile applications, also labels or continuous materials wound on rolls or reels can be printed. There is no need of setting the width a label by moving plungers. Adapted print rollers are provided for slim materials.

Label printer		SQUIX 4.3 MT	SQUIX 4 MT	
Printable resolution	dpi	300	300	600
Print speed	up to mm/s	300	300	150
Print width	up to mm	108.4	105.7	105.7

Differences to left-aligned material guidance

1 Ribbon holder

A preprinted ruler simplifies setting a ribbon.

2 Plungers

Both positions remain fixed with all widths of material. There is no need of adjustment on the print head.

3 Antistatic brush

to dissipate electrostatic charge after printing, in particular if plastic materials are in use

4 Separator

In applications requiring high heat energies, a ribbon may stick with the textile tape after printing. A draw roller reliably separates the ribbon from the material.

5 Roll holder

By applying the margin stop, a roll centers automatically

6 Material guide

attached next to the print roller to ensure accurate print images. Material widths are set with the help of a spindle

7 Slim print rollers

to obtain accurate print images if small materials and ribbons are in use. They prevent from roller wear, print head contamination and errors while materials are fed.

Synthetic rubber coating





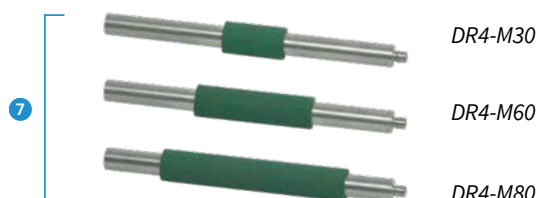





Label printer SQUIX 4 MT providing a built-on separator



Operation panel

Self-explanatory symbols help with the device settings and enable a printer to be operated intuitive and easily.

- 1 **LED:** Power ON
- 2 **Status bar:** reception of data, record data stream, pre-warning to a ribbon ending, SD memory card / USB memory stick plugged, Bluetooth, WLAN, Ethernet, USB slave, time
- 3 **Printer status:** ready, pause, number of labels printed in a print job, label in peel-off position, external start signal awaited
- 4 **USB port** to plug a service key or a memory stick, to transfer data to the IFFS memory
- 5 **Operation**
 -  Cutter / perforation cutter: cutting
 -  External rewinder: wound outside or inside
 -  Tear-off mode / peel-off mode: printing a label
 -  Applicator: printing and labeling in individual steps
 -  Jump to menu
 -  Reprint last label
 -  Stop and delete all print jobs
 -  Interrupt and continue print job
 -  Label feed

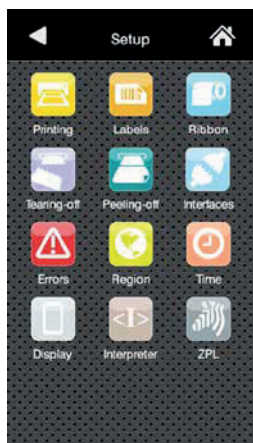

Setup options

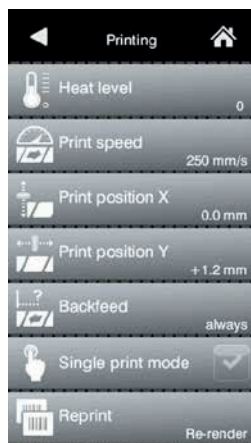

Printing parameters

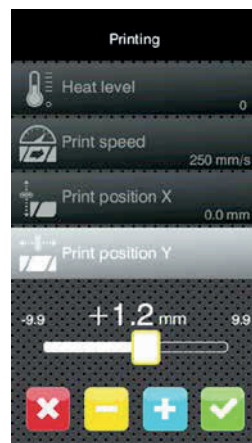

Print positions Y

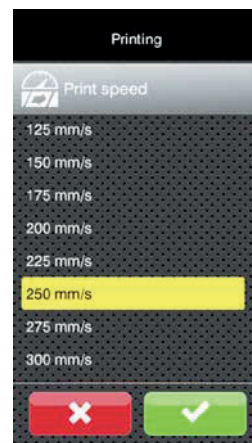

Print speeds



Video tutorials

External operation panel

If the operation panel of a printer cannot be accessed, an additional external one can be plugged.

Same functionality as on the printer

Landscape or portrait mode

Operability as desired on the external operation panel or on the printer

Printer connectivity: USB 2.0 Hi-Speed device

- 1 **LED:** Power ON
- 2 **USB port** to plug a service key or a memory stick, to transfer data to the IFFS memory
- 3 **Connecting USB cable** for power supply
cab provides specified cables. Lengths are 1.8 m to 16 m.



Print heads



A print head can be replaced by any other one, provided they are of equal width. They are detected and calibrated by the CPU automatically.

Major data such as the operational performance, maximum operational temperatures and heat energies are kept in memory on a print head. The data can be read at the premise.

Print heads provided for SQUIX 2, SQUIX 4 - 300, 600 dpi
to print sharp-edge images
to print small fonts and graphics on typeplates
to print on materials that imply high energy needs

Print heads provided for SQUIX 4.3, SQUIX 6.3 - 203, 300 dpi
durable
to operate in harsh environments, thermal direct printing

Print rollers



Two materials:

Print rollers DR

Synthetic rubber coating
highly accurate print images, provided as standard

Print rollers DRS

Silicone coating
extra long service life at a higher print image tolerance

Interfaces



1 Slot to plug a **SD memory card**

2 **2 USB hosts** to plug a service key, USB memory stick, keyboard, barcode scanner, USB Bluetooth adapter, USB WLAN stick, external operation panel

3 **USB 2.0 Hi-Speed device** to connect a PC

4 **Ethernet 10/100 Mbit/s**

5 **RS232-C** 1,200 to 230,400 baud / 8 bit

Option

6 **Digital I/O interface**

Printing is triggered by a PLC, a sensor or with the help of a hand switch. Status and error reports are displayed.

compliant to IEC/EN 61131-2, type 1+3

All the inputs and outputs are galvanically isolated and protect from reverse polarity. The outputs also protect from short circuit.

PNP inputs

Start printing or labeling
Print first label
Reprint
Delete print job
Label removed
Stop printing or labeling
Pause
Reset

PNP, NPN outputs

Device ready
Print data available
Initial / upper end position
Paper feed ON
Label in peel-off position
Label transfer / lower end position
Pre-warning to ribbon ending
Collective error

Technical data

● typical ○ possible ■ standard □ option

Label printer		Type	1.1, 1.2		1.3, 1.4			1.5, 1.6		1.7, 1.8			1.9				
			SQUIX 2		SQUIX 4.3		SQUIX 4	SQUIX 6.3		SQUIX 4.3 M		SQUIX 4 M	SQUIX 4.3MT	SQUIX 4 MT			
Material guidance			left-aligned										centered				
Printing method	Thermal transfer		●	●	●	●	●	●	●	●	●	●	●	●	●		
	Thermal direct		○	-	●	●	○	-	●	●	●	○	-	●	○	-	
Printable resolution	dpi		300	600	203	300	300	600	203	300	203	300	300	600	300	600	
Print speed	up to mm/s		250	150	300	300	300	150	250	250	300	300	300	150	300	150	
Print width	up to mm		56.9	54.1	104	108.4	105.7	105.7	168	162.6	104	108.4	105.7	105.7	108.4	105.7	
Initial print	Distance to locating edge	mm	2		2.8	1.2	2		0.5	3.2	centered						
Material¹⁾																	
Paper, cardboard, plastics PET, PE, PP, PI, PVC, PU, acrylate, Tyvec			●		●			●		●			●		●		
Shrink tube	ready for use		-		○			○		●			○				
	continuous, pressed		-		-			-		●			○				
Textile tape			-		-			-		○			●				
Packing	wound on a roll, fanfold		●		●			●		●			●				
	wound on a reel		-		-			-		●			●				
	Roll diameter	up to mm	205														
	Core diameter	mm	38.1 - 76														
Winding			outside or inside														
Labels	Width	mm	4 - 63		20 - 116			46 - 176		4 - 110			4 - 110				
	Height	no label backfeed ²⁾	from mm	4		4			6		3			4			
		label backfeed ²⁾	from mm	4		6			12		4			6			
	label backfeed peel-off	from mm	6		6			12		6			-				
Thickness			mm 0.03 - 0.6														
Liner	Width	mm	24 - 67		24 - 120			50 - 180		9 - 114			9 - 114				
	Thickness	mm	0.03 - 0.16														
Continuous material	Width	mm	24 - 67		24 - 120			50 - 180		9 - 114			9 - 114				
	Thickness	mm	0.05 - 0.5														
	Weight (cardboard)	up to g/m ²	300														
Shrink tube	Width	ready for use	-		120			-		114			114				
	continuous, pressed	mm	-		-			-		4 - 85			4 - 85				
	Thickness	up to mm	-		1.1			-		1.1			1.1				
Ribbon ³⁾	Coating			outside or inside													
	Roll diameter	up to mm	90														
	Core diameter	mm	25.4														
	Length	up to m	600														
	Width	mm	25 - 67		25 - 114			50 - 170		25 - 114			25 - 114				
Internal rewinder provided on peel-off devices																	
Outside diameter	up to mm	142															
Core diameter	mm	40															
Winding			outside														
Printer dimensions and weights																	
Width x Height x Depth	mm	200 x 288 x 460		252 x 288 x 460			312 x 288 x 460		252 x 288 x 460			252 x 288 x 460					
Weight	kg	9		10			14		10			10					
Label sensors to indicate positions																	
Transmissive sensor	detecting	labels or punch marks and materials ending, print marks on translucent materials															
Reflective sensor	reflex from below or top	detecting	labels and materials ending, print marks on non-translucent materials														
Sensor distance	to locating edge	left-aligned mm	5 - 26		5 - 60			5 - 60		-			-				
	from centre to locating edge	centered mm	-		-			-		0 - 55			0 - 55				
Material passage	up to mm	2															
Electronics																	
Processor 32 bit clock rate	MHz	800															
Main memory (RAM)	MB	256															
Data memory (IFFS)	MB	50															
Port to plug a SD memory card (SDHC, SDXC)	up to GB	512															
Battery to indicate time and date, real-time clock			■														
Data memory when power turns off (e.g. serial numbers)			■														
Interfaces																	
RS232-C 1,200 to 230,400 baud / 8 bit			■														
USB 2.0 Hi-Speed device to connect a PC			■														
Ethernet 10/100 Mbit/s			LPD, RawIP printing, SOAP webservice, OPC UA, WebDAV DHCP, HTTP/HTTPS, FTP/FTPS, TIME, NTP, Zeroconf, SNMP, VNC														
1 USB host on the operation panel	to plug a	service key, USB memory stick, USB WLAN stick, USB Bluetooth adapter															
2 USB hosts on the back of the device	to plug a	keyboard, barcode scanner, USB memory stick, USB WLAN stick, USB WLAN stick with a rod antenna, USB Bluetooth adapter, an external operation panel															
USB host, 24 VDC, to plug peripherals			■														
Digital I/O interface providing 8 inputs and outputs			□														

¹⁾ Specifications are standard values. Applications with small or strongly adhesive labels have to be tested, so are thin, slim, thick or stiff materials.

²⁾ when labels are torn off, cut, rewound

³⁾ A ribbon should be at least as wide as the liner.

Technical data

■ standard □ option

Operating data		
Voltage	100 - 240 VAC, 50/60 Hz, PFC	
Power consumption	<10 W in standby / typical are 100 W	
Temperature / humidity	Operation	+5 - 40°C / 10 - 85 %, not condensing
	Stock	0 - 60°C / 20 - 85 %, not condensing
	Transport	-25 - 60°C / 20 - 85 %, not condensing
Approvals	CE, FCC Class A, ICES-3, cULus, CB, CoC Mexico, CCC, EAC, BIS, BSMI, KC-Mark	
Operation panel		
Colored LCD touch display	Screen diagonal	" 4.3
	Resolution Width x Height	px 272 x 480
Setup options		
	Print Labels Ribbon Tear-off Peal-off Cut Apply Interfaces Error	Region: - Language - Country - Keyboard - Time zone Time Display: - Brightness - Power saving mode - Orientation Interpreter
Status bar		
	Reception of data Record data stream Pre-warning to a ribbon ending SD memory card plugged USB memory stick plugged	Bluetooth WLAN Ethernet USB slave Time
Controls		
	Ribbon winding Ribbon pre-warning Ribbon ending Material ending	Print head voltage Print head temperature Print head open Pinch roller open (peel-off device, separator) Peripheral error
Test routines		
System diagnostics	and print head detection at start up	
Display of information, test printout, analysis	Status printout	Test grid
	Fonts list	Label profile
	List of devices WLAN status	List of events Monitor mode
Status reports	- Printout of printer settings such as print lengths and service hours so far - Device status request by software command - Display of network errors, links missing, barcode errors, peripheral errors, etc. on the operation panel	
Fonts		
provided internally	5 bitmap fonts: 12 x 12 dots 16 x 16 dots 16 x 32 dots OCR-A OCR-B	7 vector fonts: AR Heiti Medium GB-Mono CG Triumvirate Cond. Bold Garuda HanWangHeiLight Monospace 821 Swiss 721 Swiss 721 Bold
to store	TrueType fonts	
Character sets	Windows-1250 to -1257 DOS 437, 737, 775, 850, 852, 857, 862, 864, 866, 869 EBCDIC 500 ISO 8859-1 to -10 and -13 to -16 WinOEM 720 UTF-8 MacRoman DEC MCS KOI8-R Western European Eastern European Chinese, simplified Chinese, traditional Thai	
Bitmap fonts	Widths and heights 1 - 3 mm Zoom factors 2 to 10 Orientations 0°, 90°, 180°, 270°	
Vector / TrueType fonts	Widths and heights 0.9 - 128 mm Continuous zoom Orientation 360° in steps of 1°	
Font styles	bold, italic, underlined, outline, inverse - depending from the font type	
Character spacing	variable or monospace	

Graphics		
Elements	lines, arrows, rectangles, circles, ellipses - filled and gradient	
Formats	PCX, IMG, BMP, TIF, MAC, GIF, PNG	
Codes		
1D barcodes (linear)	Code 39, Code 93 Code 39 Full ASCII Code 128 A, B, C EAN 8, 13 EAN/UCC 128 / GS1-128 EAN/UPC Appendix 2 EAN/UPC Appendix 5 FIM HIBC	Interleaved 2/5 Ident and routing code of Deutsche Post Codabar JAN 8, 13 MSI Plessey Postnet RSS 14 UPC A, E, E0
	2D and stacked codes	DataMatrix DataMatrix Rectangle Extension QR code Micro QR code GS1 QR code GS1 DataMatrix PDF 417 Micro PDF 417 UPS MaxiCode GS1 DataBar Aztec Codablock F Dotcode RSS 14 truncated, limited, stacked, stacked omni-directional All codes may vary in height, modular width and ratio. Orientations 0°, 90°, 180°, 270° Check digits, plain text printouts and start/stop codes are options depending from the type of code.
Software		
Label software	cablabel S3 Lite cablabel S3 Viewer cablabel S3 Pro cablabel S3 Print	■ ■ □ □
Running also with	CODESOFT NiceLabel BarTender	
Stand-alone operation		■
Windows printer drivers WHQL certified	Windows Vista Windows 7 Windows 8 Windows 8.1 Windows 10	Server 2008 Server 2008 R2 Server 2012 Server 2012 R2 Server 2016 Server 2019
Apple Mac OS X printer drivers	from version 10.6	■
Linux printer drivers	from CUPS 1.2	■
Programming	JScript printer language abc Basic Compiler ZPL II (The datastream must be tested in advance.)	■ ■ □
Integration	SAP Database Connector	■ ■
Administration	Printer control Configuration in the Intranet and Internet	■ ■

cab makes use of free and Open Source software in its products.
See information provided on www.cab.de/opensource

OPC UA

All the latest cab printers are ready to interact with machines and components of different manufacturers in industrial plants.

An OPC UA server and a client are a part of the firmware.



For further data see also the Internet:
www.cab.de/en/opcua

Label software

cablabel S3 - design, print, administrate

cablabel S3 opens up the full potential of cab devices. At first, a label must be defined. Its modular design enables cablabel S3 adapt to requirements step by step. Embedded plug-ins like the JScript Viewer support features such as native JScript programming. The designer user interface synchronizes in real time, so are JScripts codes. Integrating the Database Connector or a barcode verifier are options.

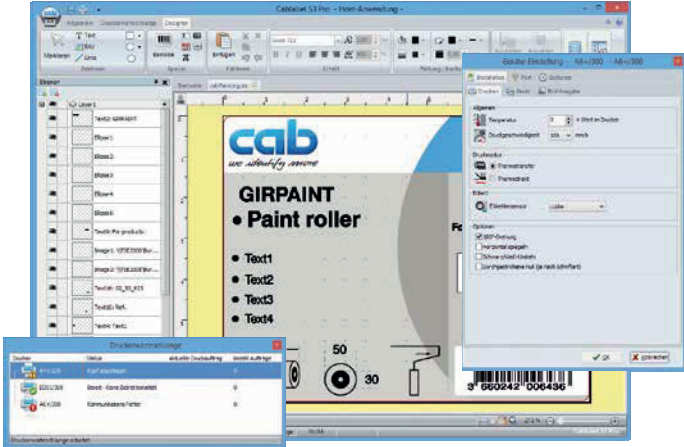

For further information see www.cab.de/en/cablabel

Stand-alone printing

Deciding for this operating mode enables a printer to select and print labels even when there is no host system connected. Labels can be designed using software such as cablabel S3 or programmed in a text editor directly on a PC. Data such as label formats, texts, graphics, as well as contents from a database can be stored on a memory card, a USB memory stick or in the printer's internal IFFS memory. Only variable data are sent by a keyboard, a barcode scanner, a scale or any other host system to a printer to be printed. It may also be recalled by the Database Connector from the host and printed.



Printer control



Drivers

cab provides 32 / 64 bit drivers to control a printer with software other than cablabel S3.



To run the drivers, operating systems need to be at least Windows¹⁾ Vista, Mac OS X²⁾ 10.6 and Linux³⁾ CUPS 1.2.



Free download on www.cab.de/en/support

Programming



JScript

cab printers embed the JScript programming language. Free manual download on www.cab.de/en/programming



abc Basic Compiler

abc in addition to JScript and as an integral firmware component enables advanced printer programming before data are edited for printout. For example, external printer languages can be replaced without intervening in the print application in progress. Data may be imported as well from other systems such as scales, barcode scanners or a PLC.

Integration



Printer Vendor Program

cab as a partner in this program developed a replace method to control cab printers from SAP⁴⁾ R/3 using SAPScript. Only variable data are sent by a host system to a printer. They unite on the printer with the images and fonts that have been stored in the local memory (IFFS, memory card, etc.).

Printer administration



Configuration in the Intranet and Internet

cab printers integrate a HTTP and FTP server. By this, a printer can be controlled and configured, firmware updated and memory cards managed using standard applications such as web browsers or FTP clients. Using SNMP/SMTP clients, the attention of administrators or operators is drawn to warnings and errors via email or SNMP datagrams. Time and date are synchronized using a time server.



Database Connector

Printers connected to a network may access data directly from a central ODBC or OLEDB database and print it on a label. While printing, data can be rewritten to the database.

¹⁾ Windows is a registered trademark of Microsoft Corporation

²⁾ MAC OS X is a registered trademark of Apple Computer, Inc.

³⁾ for device series SQUIX, MACH 4S, EOS, HERMES Q, PX Q

⁴⁾ SAP and all corresponding logos are trademarks or registered trademarks of SAP SE

Overview of accessories

● typical ○ possible ■ standard □ option

Pos.		Basic device	Peel-off device	1.1, 1.2	1.3, 1.4	1.5, 1.6	1.7, 1.8	1.9
				SQUIX 2	SQUIX 4.3 SQUIX 4	SQUIX 6.3	SQUIX 4.3 M SQUIX 4 M	SQUIX 4.3 MT SQUIX 4 MT
2.4	Print rollers DR4-M30, -M60, -M80	●	●	-	-	-	□	□
2.5	Print roller DRS	●	●	□	□	□	□	□
2.6	External operation panel	●	●	□	□	□	□	□
	Connecting USB cable	●	●	□	□	□	□	□
2.7	Antistatic brush	●	●	□	□	□	□	■
2.8	Adapter 100	●	●	□	□	□	□	□
2.9	SD memory card	●	●	□	□	□	□	□
2.10	USB memory stick	●	●	□	□	□	□	□
2.11	USB WLAN stick	●	●	□	□	□	□	□
2.12	USB WLAN stick with a rod antenna	●	●	□	□	□	□	□
2.13	USB Bluetooth adapter	●	●	□	□	□	□	□
2.14	Scanner CC200-SQ	●	●	□	□	□	□	-
Peel-off								
2.15	Present sensor PS800	-	●	□	□	□	-	-
2.16	Present sensor PS900	-	●	□	□	□	□	-
2.17	Present sensor PS1000 MP	-	●	-	-	-	□	-
2.18	Extended peel-off plate DP410	-	●	□	□	□	□	-
2.19	Reflective product sensor	-	●	□	□	□	□	-
Interfaces, switches								
3.1	Digital I/O interface	●	●	□	□	□	□	□
3.2	I/O interface plug, SUB-D, 25 pins	●	●	□	□	□	□	□
3.3	Label selection - I/O box	●	●	□	□	□	□	□
3.4	Hand switch TR2	●	●	□	□	□	□	□
3.5	Foot switch	●	●	□	□	□	□	□
Connecting cable								
4.1	Connecting RS232-C cable	●	●	□	□	□	□	□
Cutting, perforation, stacking								
5.1	Cutter CU200, CU400, CU600 tray included	●	○	□	□	□	□	□
		●	○	-	■	-	■	-
5.2	Perforation cutters PCU400/2,5, PCU400/10	●	○	-	□	-	□	□
5.3	Stacker ST400 M providing a cutter and a base frame	●	○	-	-	-	□	□
5.4	Cutter CSQ 400 tray included	●	-	-	■ or □	-	■ or □	-
Rewinding, unwinding								
6.1	Guide plates RG200, RG400	-	●	□	□	-	□	-
6.3	External rewinders ER1/210, ER2/210 ¹⁾	●	○	-	□	□	○	-
6.5	External rewinders ER4/300, ER6/300	●	○	-	□	□	○	-
6.6	External unwinders EU4/300, EU6/300	●	○	-	□	□	□	□
6.7	Kit to adapt a rewinder and/or unwinder	●	○	-	□	□	□	□
Applicators, demand modules								
7.1-7.5	Applicators S1000-220, -300, -400	-	●	□	□	□	□	-
7.6-7.8	Applicator S3200	-	●	□	□	-	□	-
7.9	Demand modules S5104, S5106	-	●	-	□	□	-	-
7.10	All-around labeler	-	●	□	□	-	□	-
7.11	Tube applicator AXON 2	-	●	-	-	-	□	-
Assembly aids								
8.1	Mounting plate	-	●	□	□	-	□	-
8.2	Profiles 40, 80, 120 mm	-	●	□	□	-	□	-
8.3	Base plate 500 x 255 mm	-	●	□	□	-	□	-
8.4	Floor stand 1600	-	●	□	□	□	□	-
8.5	Printer retainer	-	●	□	□	□	□	-
Special covers								
9.1	providing an ESD surface	●	●	□	□	□	□	□
9.2	for use in food applications	●	●	□	□	□	□	□
Protective chassis								
9.3	Stainless steel chassis to protect in food applications	●	●	-	□	□	□	-
9.4	Chassis to protect from dust	●	●	-	□	□	□	-
	Chassis to protect in cleanroom applications	●	●	-	□	□	□	-

¹⁾ designed for the A+ printer series, adapted to SQUIX; supplied until external rewinders ER20x will be available

Accessories

<p>2.4</p> 	<p>Print roller DR4-M30 to process liners and continuous materials up to 30 mm wide</p> <p>Print roller DR4-M60 to process liners and continuous materials up to 60 mm wide</p> <p>Print roller DR4-M80 to process liner and continuous materials up to 80 mm wide</p> <p>Synthetic rubber coating for highly accurate print images</p>	<p>2.15</p> 	<p>Present sensor PS800 for use with materials guided left-aligned</p> <p>Labels in peel-off position are detected. After a label has been removed, the next one is printed automatically.</p> <p>Label widths from 16 mm Label heights from 6 mm 7 mm distant from locating edge</p>
<p>2.5</p> 	<p>Print roller DRS4 to process materials up to 120 mm wide</p> <p>Silicone coating for extra long service life at a higher print image tolerance</p>	<p>2.16</p> 	<p>Present sensor PS900 for use with materials guided left-aligned or centered</p> <p>The moveable sensor in particular qualifies for detecting small or customized labels. After a label has been removed, the next one is printed automatically.</p> <p>Label widths from 4 mm Label heights from 6 mm Left-aligned: 12 - 60 mm distant from locating edge centered: position ibid.</p>
<p>2.6</p> 	<p>External operation panel If the operation panel of a printer cannot be accessed, an additional external one can be plugged.</p> <p>Same functionality as on the printer</p> <p>Landscape or portrait mode</p> <p>Operability as desired on the external operation panel or on the printer</p> <p>Printer connectivity: USB 2.0 Hi-Speed device cab provides specified connecting USB cables for power supply. Lengths are 1.8 m to 16 m.</p>	<p>2.17</p> 	<p>Present sensor PS1000 MP for use with materials guided centered</p> <p>Labels in peel-off position are detected. After a label has been removed, the next one is printed automatically.</p> <p>Label widths from 4 mm Label heights from 6 mm centered position</p>
<p>2.7</p> 	<p>Antistatic brush to dissipate electrostatic charge after printing, in particular if plastic materials are in use</p>	<p>2.18</p> 	<p>Extended peel-off plate DP410 to process labels that hardly separate from their liner due to a strong adhesive or very thick liner material. Use only if printing on demand has been triggered by the touch of a button or by a control signal. A present sensor cannot be used.</p>
<p>2.8</p> 	<p>Adapter 100 to process label rolls having a core diameter of 100 mm and outside diameters succeeding 180 mm</p>	<p>2.19</p> 	<p>Reflective product sensor to detect products automatically on a conveyor</p>
<p>2.9</p> 	<p>SD memory card</p>	<p>3.1</p> 	<p>Digital I/O interface Labeling is triggered by a PLC, a sensor or with the help of a hand switch. Status and error reports are displayed.</p>
<p>2.10</p> 	<p>USB memory stick</p>	<p>3.2</p> 	<p>I/O interface plug, SUB-D, 25 pins Clamping screws are provided to plug all the control signals to the I/O interface.</p>
<p>2.11</p> 	<p>USB-WLAN-Stick 2.4 GHz 802.11b/g/n</p> <p>Hotspot or Infrastructure Mode</p>	<p>3.3</p> 	<p>Label selection - I/O box 16 labels per box can be selected from a memory card by a superior control unit such as a PLC. Two boxes may be plugged. Using an I/O box, four inputs and outputs suffice to implement simple PLC processes via abc programming.</p>
<p>2.12</p> 	<p>USB WLAN stick with a rod antenna providing extended ranges 2.4 GHz 802.11b/g/n + 5 GHz 802.11a/n/ac</p> <p>Hotspot or Infrastructure Mode</p>	<p>3.4</p> 	<p>Hand switch TR2 to plug to the digital I/O interface</p>
<p>2.13</p> 	<p>USB Bluetooth adapter</p>	<p>3.5</p> 	<p>Foot switch to plug to the digital I/O interface</p>
		<p>4.1</p> 	<p>Connecting RS232-C cable 9/9 pins, length 3 m</p>

Cutting, verification, tube labeling

5.4



Cutter CSQ 400 provided for all basic SQUIX 4 devices assembled to a printer (see delivery program Pos. 1.12/13) or accessorial on delivery.

Paper labels and self-adhesive labels, cardboard and plastic materials, as well as shrink tubes can be cut. By pivoting the cutter, materials can be accessed to be removed. Label heights can be set on the tray.

By keeping in memory the number of cuts, wear can be controlled.

The CSQ 402 provides a more powerful engine and titanium-coated cutters. These guarantee highly performant cutting even through thick materials such as cardboard and shrink tubes, as well as through self-adhesive materials.

Cutter		CSQ 401	CSQ 402
To be used with		all basic SQUIX 4 devices	
Material	Width	up to mm	120
	Weight of cardboard	up to gr/m ²	200
	Thickness	mm	0.7
Cut length		from mm	10
	Tray to collect materials length	up to mm	100
Material passage		up to mm	2.5
Cycle performance		cuts/min	120
Service life motor no. of cuts		up to	2 mio.
	cutter no. of cuts	up to	1* mio.
Controls			5 mio.
			2* mio.
Controls		cutter has not reached final position, cover removed from cutter	

*depending from the material

2.14



Scanner CC200-SQ to detect linear 1D barcodes, 2D and stacked codes

A camera checks a code printed on a label in horizontal or vertical direction in terms of legibility or content. In the case of a bad coding, printing stops and the label can be removed by hand. Retracting such labels after stopping and identifying them by blackening is another printer option.

The scanner operates in tear-off mode and peel-off mode.

For further information see assembly instructions on www.cab.de/en/cc200

Scanner		CC200-SQ
To be used with		all SQUIX printers
Scan distance	mm	45 - 150
Scan angle	°	-15 to +15
Number of codes on a label		1
Controls	GOODBAD	check of legibility
	VERIFY	check of legibility and results compared with initial data

7.11



Applicator AXON 2 to label tubes of diameters 10 to 22 mm, or 7 to 16 mm. See AXON catalog

The tubes may be inserted and removed by hand or automatically by a gripper. They may also be ejected to a tray.

For information on the tube labeling system AXON 2 see www.cab.de/en/axon-2

Tube applicator		AXON 2
To be used with		SQUIX 4.3 MP, SQUIX 4 MP
Tubes	Diameter	mm
	Length including cap	mm
	Conicity	up to %
Labels	Materials	paper, plastics such as PET, PP
	Width	mm
	Height	from mm
Liner	Width	up to mm
Controls		applicator pivoted, tube missing, wrong tube diameter

Cutting, perforation, stacking

5.1



Cutters CU

to cut paper labels and self-adhesive labels, cardboard, textile and plastic materials, as well as shrink tubes.

Tray to collect a maximum of approx. 50 labels

Cutter			CU200	CU400		CU600
To be used with			SQUIX 2	SQUIX 4.3 SQUIX 4	SQUIX 4.3 M SQUIX 4 M SQUIX 4.3 MT SQUIX 4 MT	SQUIX 6.3
Material	Width	up to mm	67	120	114	180
	Weight of cardboard	gr/m ²	60 - 300			
	Thickness	mm	0.05 - 1.1			
Cut length		from mm	5			
Material passage		up to mm	2.5			
Cycle performance		cuts/min with material 1 mm high, no backfeed	100			
Stop printing if			cutter has not reached final position			
Tray						
Label height		up to mm	-	100	-	-

5.2



Perforation cutters PCU400

perforate continuous materials such as textile tapes or shrink tubes to simplify separation by hand. Cutting the material is also possible.

Perforation cutter			PCU400/2,5	PCU400/10
To be used with			SQUIX 4.3, SQUIX 4, SQUIX 4.3 M, SQUIX 4 M, SQUIX 4.3 MT, SQUIX 4 MT	
Perforation	Web spacing	mm	2.5	10
	Web width	mm	0.5	
Material	Width	up to mm	85	
	Weight of cardboard	gr/m ²	60 - 300	
	Thickness	mm	0.05 - 1.1	
Cut length		from mm	5	
Material passage		from mm	2.5	
Cycle performance		cuts/min with material 1 mm high, no backfeed	100	
Stop printing if			cutter has not reached final position	

5.3



Stacker ST400 M providing a cutter

- Printed materials are cut and collected. As soon as stacking has reached its maximum height, printing interrupts. Limitations may occur with stiff or curved materials. We recommend to have such applications tested by cab.
- Devices can be set anywhere on a table with the help of a base frame.

Stacker providing a cutter			ST400 M
To be used with			SQUIX 4.3 M, SQUIX 4 M SQUIX 4.3 MT, SQUIX 4 MT
Material	Width	mm	20 - 100
	Weight of cardboard	gr/m ²	60 - 300
	Thickness	mm	0.05 - 0.8
Cut length		mm	20 - 150
Material passage		up to mm	1.2
Cycle performance		cuts/min with material 1 mm high, no backfeed	100
Stop printing if			cutter has not reached final position, paper jam, stacker cover open, stacking has reached maximum height
Stacking height		up to mm	100



Support table - label W x H

The table and the protective cover adapt to the label size. To be requested individually

Rewinding, unwinding with or without the use of a cardboard core



Guide plates RG enable labels to be rewound internally on peel-off printers. The peel-off plate is therefore replaced by a guide plate.

Guide plate		RG200	RG400		
	To be used with	SQUIX 2 P	SQUIX 4.3 P SQUIX 4 P	SQUIX 4.3 MP SQUIX 4 MP	
	Material width	up to mm	67	120	114
	Roll diameter	up to mm	142		
	Tightening axle core diameters of	mm	38.1 - 40		
	Winding		outside		

External rewinders ER1, ER2 to plug directly to a printer using screws. They pick up materials wound either on the outside or on the inside. An electronic swing arm keeps winding consistent and tight.

SQUIX M:
An adapted roll holder is recommended when processing slim materials.

External rewriter	ER1/210	ER2/210	
To be used with	SQUIX 4.3, SQUIX 4 SQUIX 4.3 M, SQUIX 4 M	SQUIX 6.3	
Material width	up to mm	120	180
Roll diameter	up to mm	205	
Tightening axle core diameters of	mm	76	
Winding		outside or inside	

External rewinders ER4, ER6 providing a built-in power supply unit. They operate also with printers other than cab. They pick up materials wound either on the outside or on the inside. An electronic swing arm keeps winding consistent and tight.

External rewriter	ER4/300	ER6/300	
To be used with	SQUIX 4.3, SQUIX 4 SQUIX 4.3 M, SQUIX 4 M	SQUIX 6.3	
Material width	up to mm	120	180
Roll diameter	up to mm	300	
Tightening axle core diameters of	mm	76	
Winding		outside or inside	

Kit to adapt
ER4, ER6 to a SQUIX printer
ER4, ER6 and EU4, EU6 to a SQUIX printer

External unwinders EU enable labels to be fed consistent even if rolls are heavy. They pick up materials wound either on the outside or on the inside.

External unwinder	EU4/300	EU6/300		
To be used with	SQUIX 4.3 SQUIX 4	SQUIX 4.3 M SQUIX 4 M SQUIX 4.3 MT SQUIX 4 MT	SQUIX 6.3	
Material width	up to mm	120	114	180
Roll diameter	up to mm	300		
Core diameter	up to mm	38.1		
	adapter included mm	76		
Winding		outside or inside		

Kit to adapt
EU4, EU6 to a SQUIX printer
ER4, ER6 and EU4, EU6 to a SQUIX printer

Applicator S1000



Labeling in real time

A S1000 assembled to a SQUIX peel-off printer provides a cost-effective solution if operated semi-automatically or integrated in vertical orientation in production lines. A stroke cylinder applies the labels to products.

- 1 **Long service life**
The ball bearing guide bars are low-wear.
- 2 **Products of different heights**
can be labeled by means of a stroke cylinder. Various stroke lengths are provided.
- 3 **Compressed air regulation unit**
Micro filters prevent from contamination. Regulating the pressure ensures a permanent good labeling quality.
- 4 **Highly-reliable processes**
The supporting air, intake air and stroke speed may be adapted. If sensitive products and packagings are in use, the pressing force can be reduced to less than 10N (1 kg). To prevent intake ducts from contamination, they get purged after any labeling.
- 5 **Label sizes**
Labels 25 to 176 mm wide and 25 to 200 mm high can be applied.
- 6 **Supporting air**
to blow labels onto a pad
- 7 **Pad**
Labels are transferred to a pad and held there by vacuum. They move towards a product by means of a stroke cylinder.

Pre-dispense button

to verify a labeling process. By pushing the button once, a label is printed and transferred to the applicator. By pushing the button once more, labeling is triggered.

Applicator		S1000-220	S1000-300	S1000-400
To be used with		SQUIX 2, SQUIX 4.3, SQUIX 4 SQUIX 4.3 M, SQUIX 4 M, SQUIX 6.3		
Cylinder stroke	mm	220	300	400
Pad stroke below the device	mm	64	144	244
Compressed air	bar	4.5		
Cycle rate	labels/min approx. ¹⁾	25		

¹⁾ calculated at a stroke of 100 mm below the device, with labels 100 mm high, at a print speed of 100 mm/s

Accessories

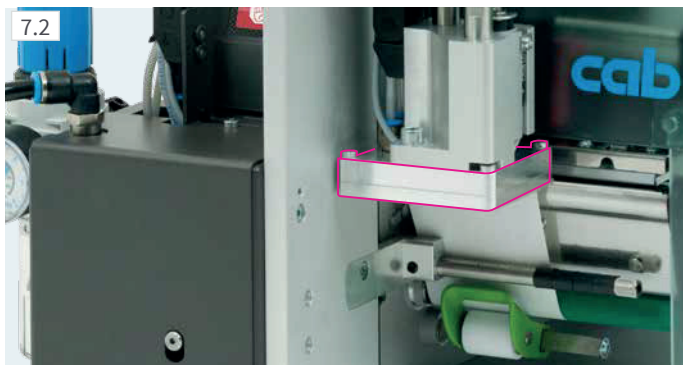

Universal pads

Drilled intake holes are arranged in a grid and covered by foil, to be pierced according to the size of a label.

Universal pad		A1021		A1021
To be used with		SQUIX 2	SQUIX 4.3 SQUIX 4	SQUIX 4.3 SQUIX 4
Label width	mm	25 - 63	25 - 70	25 - 90
Label height	mm	25 - 60		25 - 90
Product surface		flat		
Product height		various		
State of a product during labeling		at rest		

Applicator S1000 accessories

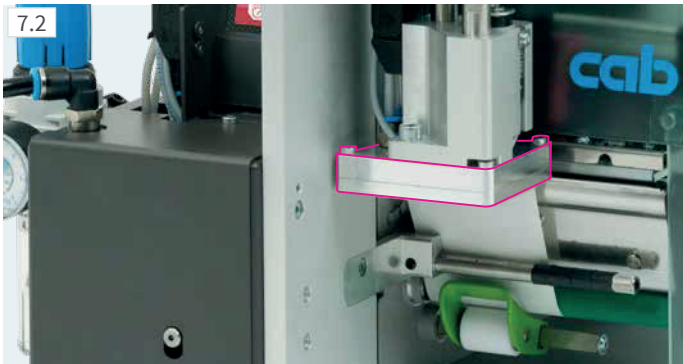

Tamp pads

are manufactured according to the size of a label.

Tamp pad		A1021		
To be used with		SQUIX 2	SQUIX 4.3 SQUIX 4	SQUIX 6.3
Label width	mm	25 - 63	25 - 116	50 - 176
Label height	mm	25 - 200		
Product surface		flat		
Product height		various		
State of a product during labeling		at rest		

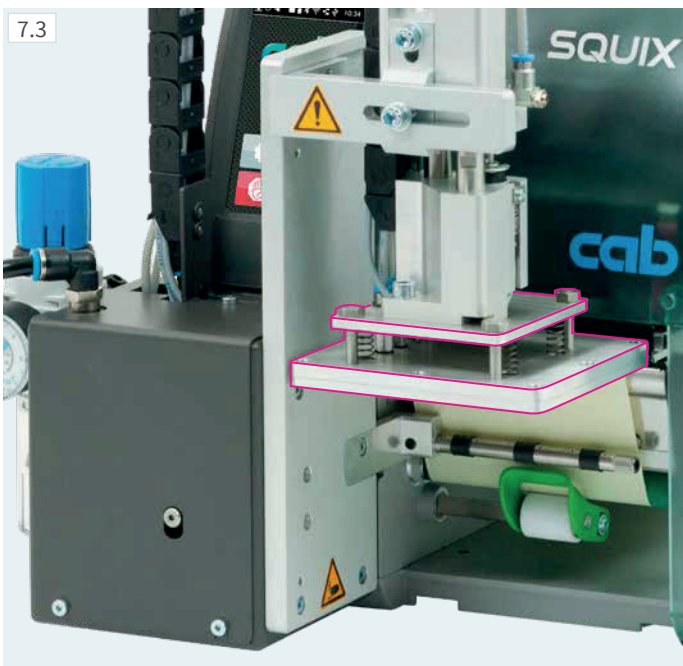

Universal pads, spring-mounted

Pitch of spring enables labels to apply even on inclined surfaces. Drilled intake holes are arranged in a grid and covered by foil, to be pierced according to the size of a label.

Universal pad		A1321	A1321
To be used with		SQUIX 4.3, 4	SQUIX 4.3, 4
Label width	mm	25 - 116	25 - 116
Label height	mm	25 - 102	25 - 152
Product surface		flat	
Product height		various	
State of a product during labeling		at rest	

Tamp pads, spring-mounted

Pitch of spring enables labels to apply even on inclined surfaces. Manufacture according to the size of a label

Tamp pad		A1321	
To be used with		SQUIX 4.3, 4	SQUIX 6.3
Label width	mm	25 - 116	50 - 176
Label height	mm	25 - 200	
Product surface		flat	
Product height		various	
State of a product during labeling		at rest	

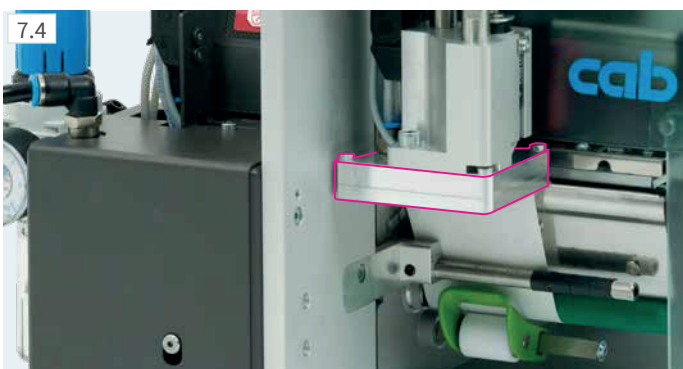

Blow pads

to apply labels on products sensitive to pressure. A pad moves to a height fixed approx. 10 mm above a product to trigger labeling.

Blow pad		A2021		
To be used with		SQUIX 2	SQUIX 4.3, 4	SQUIX 6.3
Label width	mm	25 - 63	25 - 116	provided on request
Label height	mm	25 - 100		
Product surface		flat		
Product height		fixed		
State of a product during labeling		at rest or in motion		

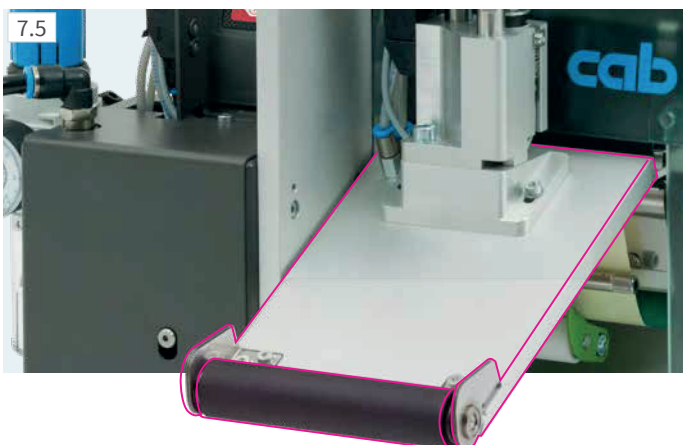

Roll-on pads

Labels are fed to the roller of a pad during printing. The pad then moves to the product. Labels are picked up by the product in motion and rolled on.

Roll-on pad		A1411	
To be used with		SQUIX 4.3, 4	SQUIX 6.3
Label width	mm	25 - 116	50 - 176
Label height	mm	80 - 200	
Product surface		flat	
Product height		various	
State of a product during labeling		in motion	

Applicator S3200

7.6

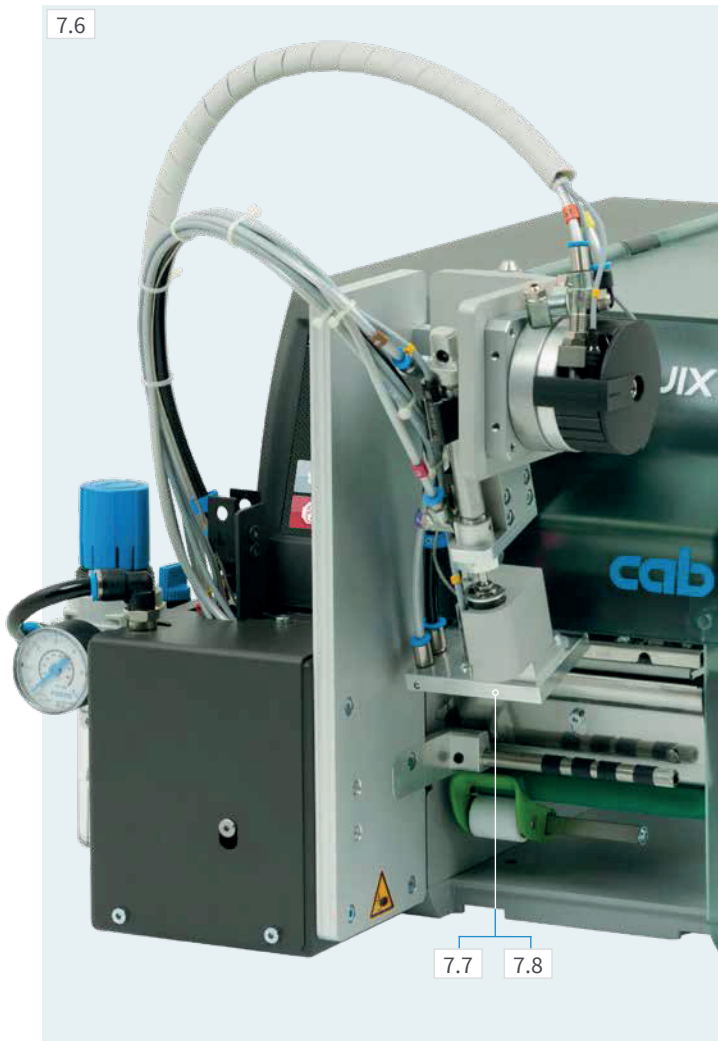

Labeling in real time

A S3200 assembled to a SQUIX peel-off printer provides a cost-effective solution if operated semi-automatically or integrated in production lines. Printed labels are applied to products automatically. For this purpose, labels are set 45° to 95° to the horizontal by a rotary cylinder and move towards products by means of a short-stroke cylinder.

In terms of service life, pre-dispense, compressed air regulation, process reliability and supporting air, data correspond to the S1000 applicator (see page 18).

Applicator	S3200	
To be used with	SQUIX 2, SQUIX 4.3, SQUIX 4, SQUIX 4.3 M, SQUIX 4 M	
Rotary cylinder	45° - 95°	
Stroke cylinder	up to mm	30
Immersion depth	up to mm	5
Compressed air	bar	4.5
Cycle rate labels/min approx. ¹⁾	20	

¹⁾ calculated with labels 40 mm high, at a print speed of 100 mm/s

Tamp pads or blow pads

are manufactured according to the size of a label.

Tamp pad	A3200-1100	
To be used with	SQUIX 2	SQUIX 4.3, 4
Label width	mm 4 - 63	10 - 116
Label height	mm	6 - 80
Product surface	flat	
State of a product during labeling	at rest	
Blow pad	A3200-2100	
To be used with	SQUIX 2	SQUIX 4.3, 4
Label width	mm 10 - 63	10 - 116
Label height	mm	10 - 80
Product surface	flat	
State of a product during labeling	at rest or in motion	

Demand modules

7.9



Demand modules S5104, S5106

label products in motion on a conveyor. Positions are detected by a product sensor. As soon as peel-off has been triggered, the next label is printed. The speed of a product on the conveyor must adapt to the print speed. A reflective sensor detects positions.

Demand module	S5104	S5106
To be used with	SQUIX 4.3, SQUIX 4	SQUIX 6.3
Label width	mm 25 - 116	50 - 176
Label height	mm	25 - 210
Print line distance to the peel-off plate	mm	336 - 518
Product surface	flat	
Product height	fixed	
State of a product during labeling	in motion, speed adapted to the printer	
Cycle rate labels/min approx. ¹⁾	60	

¹⁾ calculated with labels 100 mm high, at a print speed of 100 mm/s

All-around labeler



All-around labeler

to label cylindric items on a 360° circumference. Products are laid onto the rollers and labeling is triggered via a hand switch or a foot switch.

Delivery includes a mount, a cable to connect to a SQUIX printer, and a foot switch

Tamp pad	A1021	M1021
To be used with	SQUIX 2	SQUIX 4.3, SQUIX 4
Label width mm	25 - 63	25 - 116
Label height mm	25 - 140	
Product diameter mm	12 - 40	
Product surface	cylindric	
State of a product during labeling	in rotary motion	

Assembly aids provided for SQUIX label printers

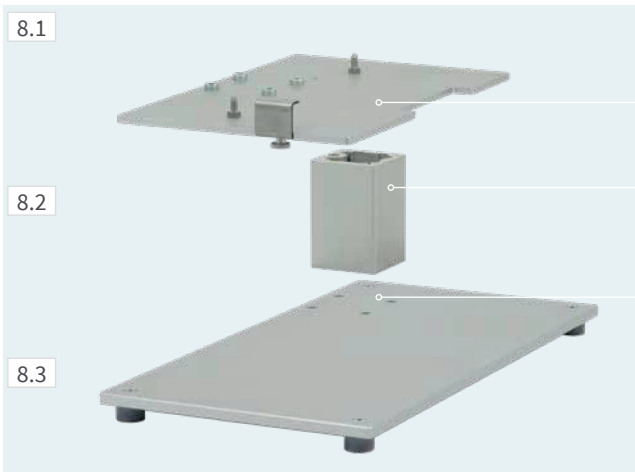

Mount

to assemble a labeling system and a product retainer

- 1 **Mounting plate**
to assemble a labeling system
- 2 **Profile**
aluminum square
40, 80, 120 mm; further lengths may be provided on request
- 3 **Base plate**
to assemble a product retainer
500 x 255 mm standard size



Floor stand

to enable a printer operate quickly and flexibly in any production line. Positions (i.e. heights, widths) on which products need to be labelled can be set in few steps. Four guide rollers on the carriage provide mobility. To be aligned on site using adjustable feet

Floor stand	1600
Total height mm	1,600
Labeling heights up to mm	1,400
Outreach to centre of label mm	230 - 500
Carriage dimensions W x H x D mm	600 x 140 x 860



Printer retainer

to fix and quick-lock a label printer

Label printers providing special covers or protective chassis

1.10



Printers providing a conductive ESD surface

available for all printer types

All the parts of a casing are manufactured according to DIN EN 61340-5-1:2016 to protect from electrostatic charge.

Surface resistant according to DIN IEC 60093 $\leq 10^4$ ohm; charge reduces from 1,000 V to 100 V in less than two seconds

The hinged cover with the upper device plate (as a unit) are provided as a spare part.

1.11



Printers for use in food applications

available for all printer types

Covers are magnetic so that splintered parts can be detected by metal detectors or x-ray inspection systems.

Blue color serves for optical differentiation from food.

The entire casing may be manufactured detectable on request.

The materials manufactured comply with food regulations such as EU Nr. 10/2011 and FDA CFR 21 177.2600.

9.3



Stainless steel chassis to protect in food applications

available for SQUIX 4 and SQUIX 6 printers

Labels are removed through the front.

The front has to be opened and the printer pulled out on telescopic rails to replace materials. Close the front for steam jet cleaning.

Protection class IP69K according to EN 60529

9.4



Chassis to protect from dust

available for SQUIX 4 and SQUIX 6 printers

Labels are removed through the front.

The fan with a filter provide overpressure and prevent from dust entering the chassis.

Protection class IP52 according to EN 60529

Chassis providing a suction nozzle to protect in cleanroom applications

available for SQUIX 4 and SQUIX 6 printers

Maintenance



Label sensors

unlock by touch to be pulled out.



Print heads

require few steps to be replaced.
In general, no adjustments are needed.



Print rollers

are quick and easy to remove using a screw.

ONE tool

is provided ready on a device to replace all the components
and assemble periphery.



Service

Trained cab technicians provide worldwide support
in maintenance and repair matters.

Send your printer to a cab service point or a selected service partner.
Your device will be checked and repaired within few workdays.
If required, a loan unit will bridge the gap.

You prefer maintenance and repair in your company?
Then make an appointment with our Service Department:
phone **+49 721 6626 300**, email: service.de@cab.de

Trainings

Refresh your know-how of cab devices
as regards efficient operation, service and repair.



Our trainings in Karlsruhe provide information
on how to operate a device, label design, software,
printer drivers, programming, database access
and how to integrate in a network or a superior ERP system.
We gladly send you comprehensive data on our current trainings.

**We also offer trainings adapted to your demands
- either at our premise in Karlsruhe or in your company.**



Delivery program of label printers

Pos.	Part no.	Label printers with left-aligned material guidance
1.1	 5977030 5977031	Label printer SQUIX 2/300 Label printer SQUIX 2/600
1.2	 5977032 5977033	Label printer SQUIX 2/300P Label printer SQUIX 2/600P
1.3	 5977014 5977015 5977001 5977002	Label printer SQUIX 4.3/200 Label printer SQUIX 4/300 Label printer SQUIX 4/600
1.4	 5977016 5977017 5977004 5977005	Label printer SQUIX 4.3/200P Label printer SQUIX 4.3/300P Label printer SQUIX 4/300P Label printer SQUIX 4/600P
1.5	 5977034 5977035	Label printer SQUIX 6.3/200 Label printer SQUIX 6.3/300
1.6	 5977036 5977037	Label printer SQUIX 6.3/200P Label printer SQUIX 6.3/300P
Pos.	Part no.	Label printers with centered material guidance
1.7	 5977018 5977019 5977010 5977011	Label printer SQUIX 4.3/200M Label printer SQUIX 4.3/300M Label printer SQUIX 4/300M Label printer SQUIX 4/600M
1.8	 5977022 5977023 5977007 5977008	Label printer SQUIX 4.3/200MP Label printer SQUIX 4.3/300MP Label printer SQUIX 4/300MP Label printer SQUIX 4/600MP
1.9	 5977024 5977012 5977025	Label printer SQUIX 4.3/300MT Label printer SQUIX 4/300MT Label printer SQUIX 4/600MT



Pos.	Part no.	Optional label printers
1.10	 5977xxx.124	Printers providing an ESD surface Label printer SQUIX x/xxx-ESD
1.11	 5977xxx.122	Printers for use in food applications Label printer SQUIX x/xxx-FOOD

x - user-specific part no. following request

Pos.	Part no.	Label printers with cutter CSQ
1.12	 5977014.648 5977018.648 5977001.648 5977010.648 5977002.648 5977011.648	Label printer SQUIX 4.3/200-C1 Label printer SQUIX 4.3/200M-C1 Label printer SQUIX 4/300-C1 Label printer SQUIX 4/300M-C1 Label printer SQUIX 4/600-C1 Label printer SQUIX 4/600M-C1
1.13	5977014.649 5977018.649 5977001.649 5977010.649 5977002.649 5977011.649	Label printer SQUIX 4.3/200-C2 Label printer SQUIX 4.3/200M-C2 Label printer SQUIX 4/300-C2 Label printer SQUIX 4/300M-C2 Label printer SQUIX 4/600-C2 Label printer SQUIX 4/600M-C2

























Scope of delivery
Label printer Power cable type E+F, length 1.8 m Connecting USB cable, length 1.8 m Instructions DE/EN

Available online	
 https://setup.cab.de/en	Instructions in 30 languages Configuration manuals DE/EN/FR Service manuals DE/EN Spare parts lists DE/EN Programming manual EN Windows printer drivers WHQL certified for Windows Vista Server 2008 Windows 7 Server 2008 R2 Windows 8 Server 2012 Windows 8.1 Server 2012 R2 Windows 10 Server 2016 Server 2019 Apple Mac OS X printer drivers DE/EN/FR Linux printer drivers DE/EN/FR cablabel S3 Lite software cablabel S3 Viewer Database Connector

Pos.	Part no.	Wear parts
2.1	 5977384.001 5977385.001	Print head 2/300 Print head 2/600
	5977382.001 5977383.001	Print head 4.3/200 Print head 4.3/300
	5977444.001 5977380.001	Print head 4/300 Print head 4/600
	5977386.001 5977387.001	Print head 6.3/200 Print head 6.3/300
2.2	 5954102.001 5954180.001 5954245.001	Print roller DR2 Print roller DR4 Print roller DR6
2.3	 5954104.001 5954183.001 5954246.001	Guide roller RR2 Guide roller RR4 Guide roller RR6

Delivery program of accessories

Pos.	Part no.	
2.4	 5953700.001	Print roller DR4-M30
	 5953701.001	Print roller DR4-M60
	 5953702.001	Print roller DR4-M80
2.5	 5954978.001	Print roller DRS2
	 5954985.001	Print roller DRS4
	 5954979.001	Print roller DRS6
2.6	 6010186	External operation panel
	 5907718.850	Connecting USB cable, length 1.8 m
	 5907730.850	Connecting USB cable, length 3 m
	 5907750.850	Connecting USB cable, length 5 m
	 5907760.850	Connecting USB cable, length 11 m
	 5907765.850	Connecting USB cable, length 16 m
2.7	 5977797	Antistatic brush 2"
	 5977339	Antistatic brush 4" / 6"
2.8	 5959622	Adapter 100
2.9	 5977370	SD memory card
2.10	 5977730	USB memory stick
2.11	 5978912.001	USB WLAN stick 2.4 GHz 802.11b/g/n
2.12	 5977731	USB WLAN stick with a rod antenna 2.4 GHz 802.11b/g/n + 5 GHz a/n/ac
2.13	 5977732	USB Bluetooth adapter
2.14	 5977840	Scanner CC200-SQ
Pos.	Part no.	Peel-off
2.15	 5977585	Present sensor PS800
2.16	 5984482	Present sensor PS 2/900
	 5977538	Present sensor PS 4/900
2.17	 5977735	Present sensor PS1000 MP
2.18	 5977798	Extended peel-off plate DP210
	 5978908	Extended peel-off plate DP410
	 5977799	Extended peel-off plate DP610
2.19	 5978909	Reflective product sensor

Pos.	Part no.	Interfaces, switches
3.1	 5977767	Digital I/O interface
3.2	 5917651	I/O interface plug, SUB-D, 25 pins
3.3	 5948205	Label selection - I/O box
3.4	 5955710	Hand switch TR2
3.5	 5955711	Foot switch
Pos.	Part no.	Connecting cable
4.1	 5550818	Connecting RS232-C cable 9/9 pins, length 3 m
Pos.	Part no.	Cutting, perforation, stacking
5.1	 5979032	Cutter CU200
	 5978900	Cutter CU400 tray included
	 5979033	Cutter CU600
5.2	 5978901	Perforation cutter PCU400/2,5
	 5978920	Perforation cutter PCU400/10
5.3	 5978902	Stacker ST400 M providing a cutter and a base frame
	 xxxxxxx	Base frame, label W x H
5.4	 5984550	Cutter CSQ 401 tray included
	 5984565	Cutter CSQ 402 tray included
Pos.	Part no.	Rewinding, unwinding
6.1	 5979031	Guide plate RG200
	 5978903	Guide plate RG400
6.3	 5948102.597	External rewinder ER1/210
	 5943251.597	External rewinder ER2/210
6.5	 5946090	External rewinder ER4/300
	 5946420	External rewinder ER6/300
6.6	 5946091	External unwinder EU4/300
	 5946421	External unwinder EU6/300
6.7	 5978943	Kit to adapt ER4, ER6 and EU4, EU6

Delivery program of accessories

Pos.	Part no.	Applicators, demand modules
7.1	5976086 5976087 5976088	Applicator S1000-220 Applicator S1000-300 Applicator S1000-400
7.2	5949072	Universal pad A1021 up to 70 x 60
	5949075	Universal pad A1021 up to 90 x 90
	xxxxxxx	Tamp pad A1021 W x H
7.3	5949076	Universal pad A1321 up to 116 x 102
	5949077	Universal pad A1321 up to 116 x 152
	xxxxxxx	Tamp pad A1321 W x H
7.4	xxxxxxx	Blow pad A2021 W x H
7.5	xxxxxxx	Roll-on pad A1411 W x H
7.6	5976085	Applicator S3200
7.7	xxxxxxx	Tamp pad A3200-1100 W x H
7.8	xxxxxxx	Blow pad A3200-2100 W x H
7.9	5976083 5979035	Demand module S5104 Demand module S5106
7.10	5976084	All-around labeler
	5979089 5550999 8930933.001	Mount Cable to connect to a SQUIX printer Foot switch
	5979509	Tube applicator AXON 2 providing a TRV transport roller a tray a peel-off plate 56

x - user specific part no. following request

Pos.	Part no.	Assembly aids
8.1	5979036 5978910 5978923	Mounting plate SQUIX 2 Mounting plate SQUIX 4 Mounting plate SQUIX 6
8.2	5958365 5965929 5971136	Profile 40 Profile 80 Profile 120 further lengths provided on request
8.3	5961203	Base plate 500 x 255
8.4	5947400	Floor stand 1600
8.5	5979037 5978922 5979038	Printer retainer SQUIX 2 Printer retainer SQUIX 4 Printer retainer SQUIX 6
Pos.	Part no.	Special covers
9.1	5977771.001 5977763.001 5977772.001	Hinged cover SQUIX 2-ESD Hinged cover SQUIX 4-ESD Hinged cover SQUIX 6-ESD
9.2	5977773.001 5977764.001 5977774.001	Hinged cover SQUIX 2-FOOD Hinged cover SQUIX 4-FOOD Hinged cover SQUIX 6-FOOD
Pos.	Part no.	Protective chassis
9.3	5979071 5979305	Stainless steel chassis SQUIX 4 Stainless steel chassis SQUIX 6
9.4	5979080	Chassis SQUIX 4 220 V to protect from dust
	5979300	Chassis SQUIX 6 220 V to protect from dust
	5979080.126 5979300.126	Chassis SQUIX 4 to protect in cleanroom applications Chassis SQUIX 6 to protect in cleanroom applications
Pos.	Part no.	Label software
11.7	Bundle	cablabel S3 Lite (download on cab.de/en)
	5588001	cablabel S3 Pro 1 WS
	5588100	cablabel S3 Pro 5 WS
	5588101	cablabel S3 Pro 10 WS
	5588150	cablabel S3 Pro 1 additional licence
	5588151	cablabel S3 Pro 4 additional licences
	5588152	cablabel S3 Pro 9 additional licences
	5588002	cablabel S3 Print 1 WS
	5588105	cablabel S3 Print 5 WS
	5588106	cablabel S3 Print 10 WS
5588155	cablabel S3 Print 1 additional licence	
5588156	cablabel S3 Print 4 additional licences	
5588157	cablabel S3 Print 9 additional licences	
	in preparation	cablabel S3 Print Server
11.10	9009950	Programming manual EN, printed copy